



tecnologia  
ferro  
flessibilità

LAIFE SpA Via dei Guazzi 25, 52014 Poppi (AR)  
Tel. 0575-529333 Fax 0575-529498 Mail: info@laife.it

# Silos Componibili Ø5000

Scheda tecnica N°:  
STD-SCL50

Data  
29/07/2010

Rev.  
A

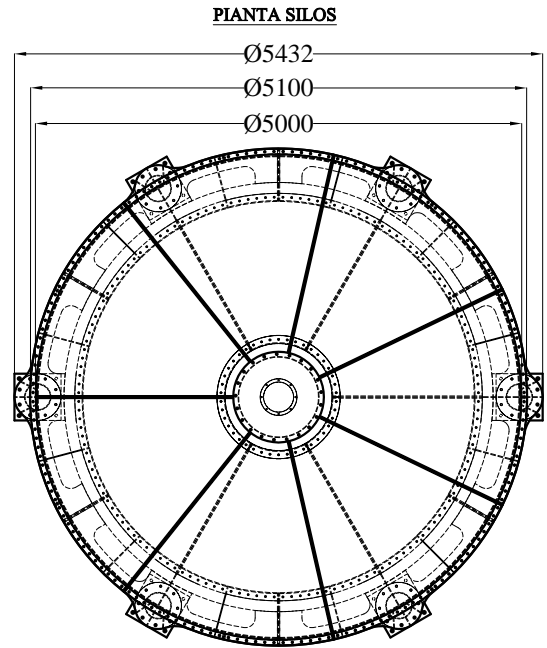
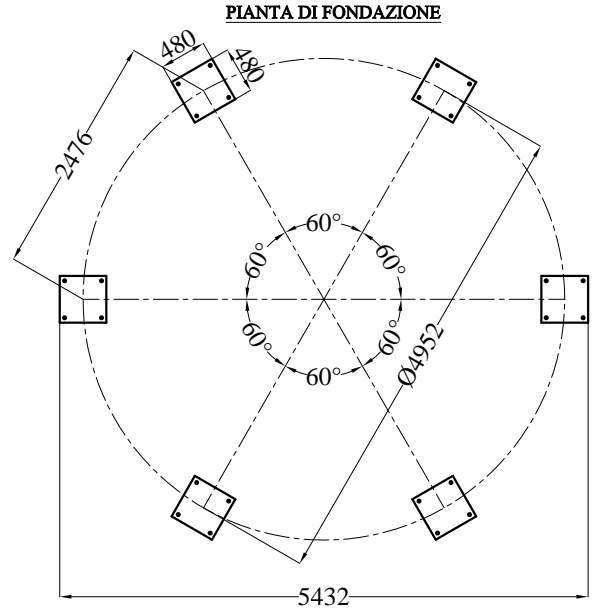
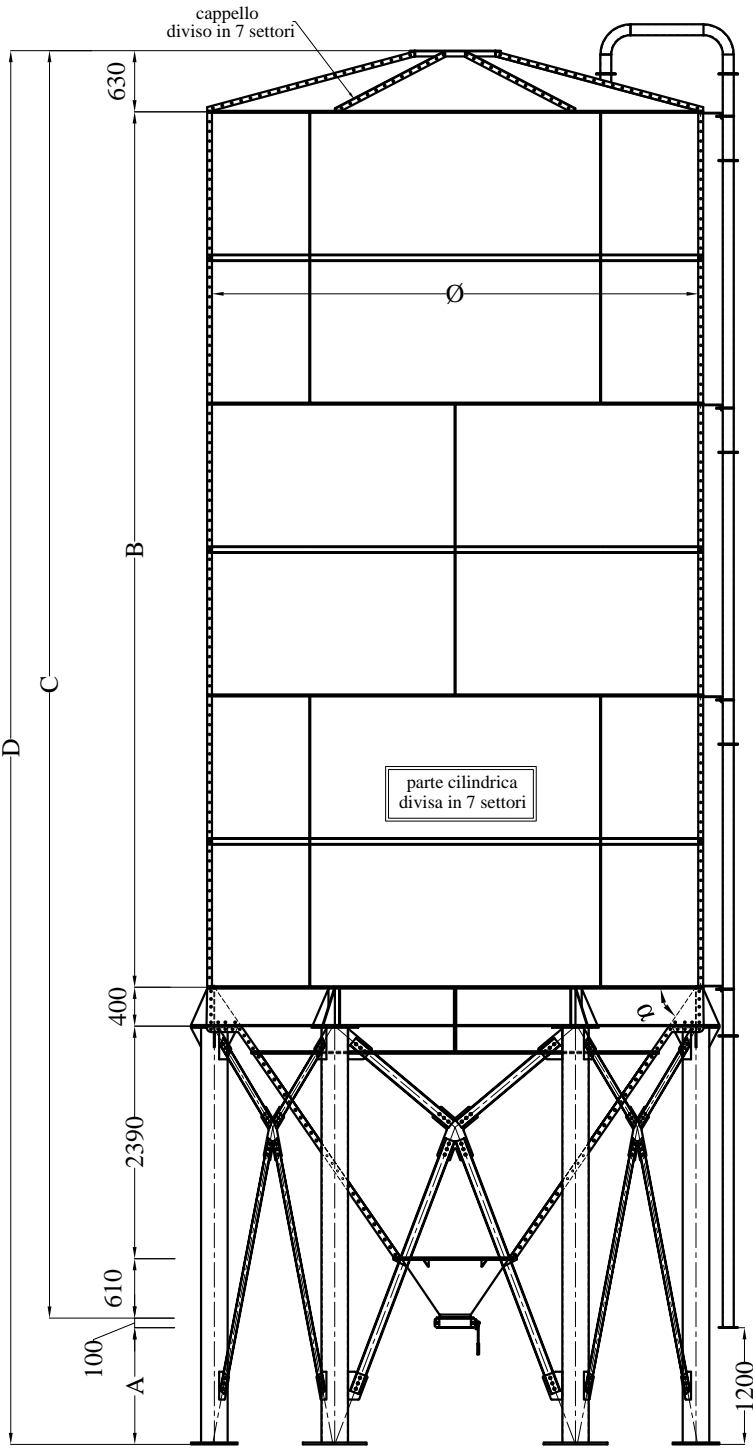

**PIASTRA DI FONDAZIONE**

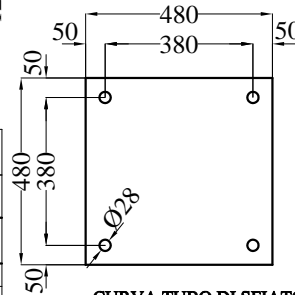

**CURVA TUBO DI SFIATO**

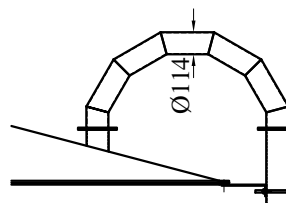

**FLANGIA FINALE TUBO DI CARICO**

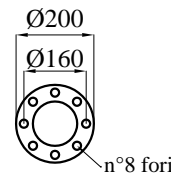

**FLANGIA DI USCITA CONO SILOS**

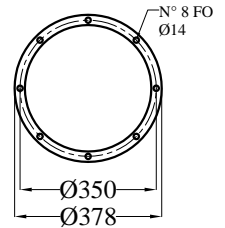

**CURVA TUBO DI CARICO**

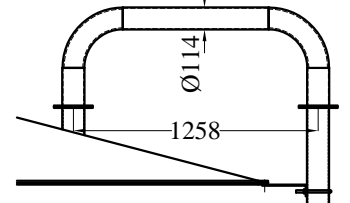

Tipologia cono	Silos Componibili inclinazione cono STANDARD $\alpha=55^\circ$					
Codice	SCL50-110	SCL50-140	SCL50-170	SCL50-200	SCL50-230	SCL50-250
<b>CAPACITA' Mc</b>	110	140	170	200	230	260
<b>N. VIROLE</b>	1X1500	-----	1X1500	-----	1X1500	-----
	1X3000	2X3000	2X3000	3X3000	3X3000	4X3000
<b>Ø</b>	5000	5000	5000	5000	5000	5000
<b>A</b>	1000	1000	1000	1000	1000	1000
<b>B</b>	4500	6000	7500	9000	10500	12000
<b>C</b>	8530	10030	11530	13030	14530	16030
<b>D</b>	9630	11130	12630	14130	15630	17130